

Zamki magnetyczne AGB - MEDIANA POLARIS

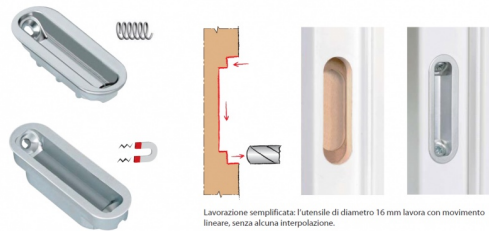

Lavorazione semplificata: l'utensile di diametro 16 mm lavora con movimento lineare, senza alcuna interpolazione.

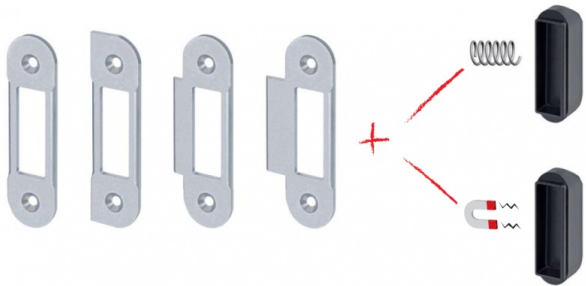
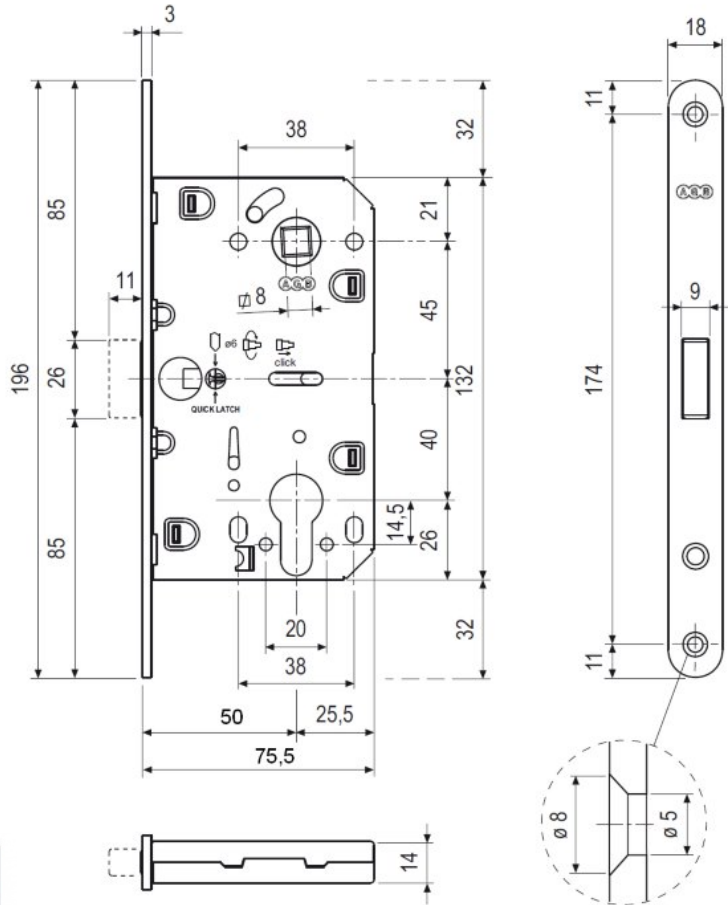
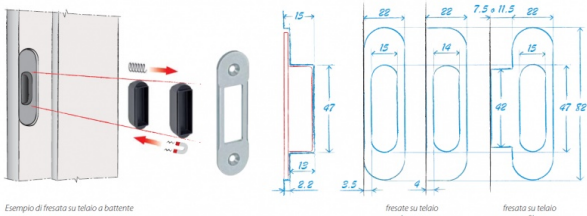

Esempio di fresata su telaio a battente

fresate su telaio a battente

fresata su telaio a filo

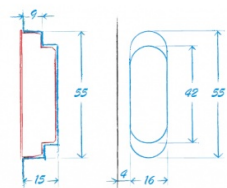
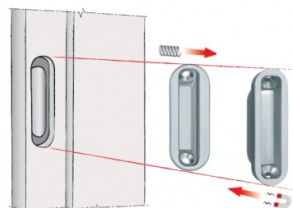

fresata su telaio a battente

Zamki magnetyczne AYR - CERRAMAGIC



AYR Cerramagic 825

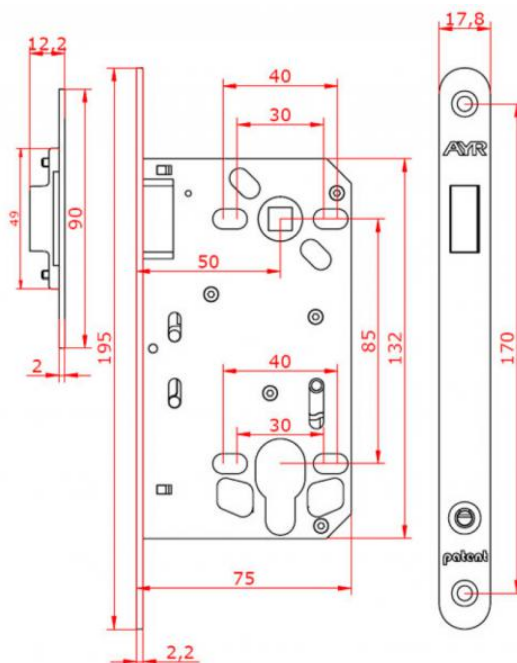

AYR Cerramagic 824

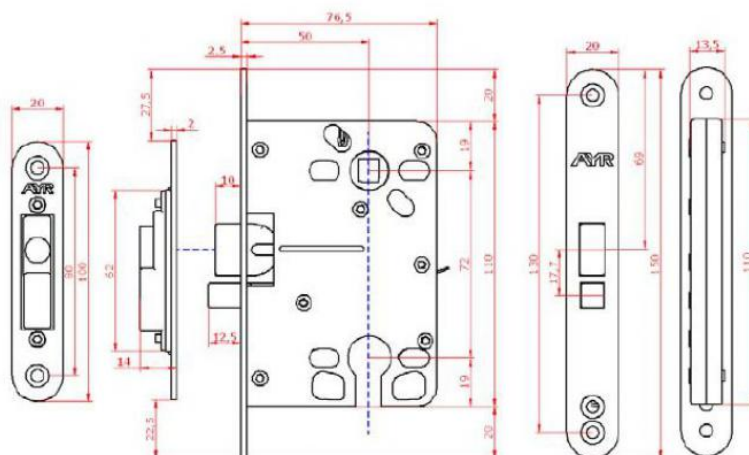

Zamki magnetyczne BONAITI

B-TWO

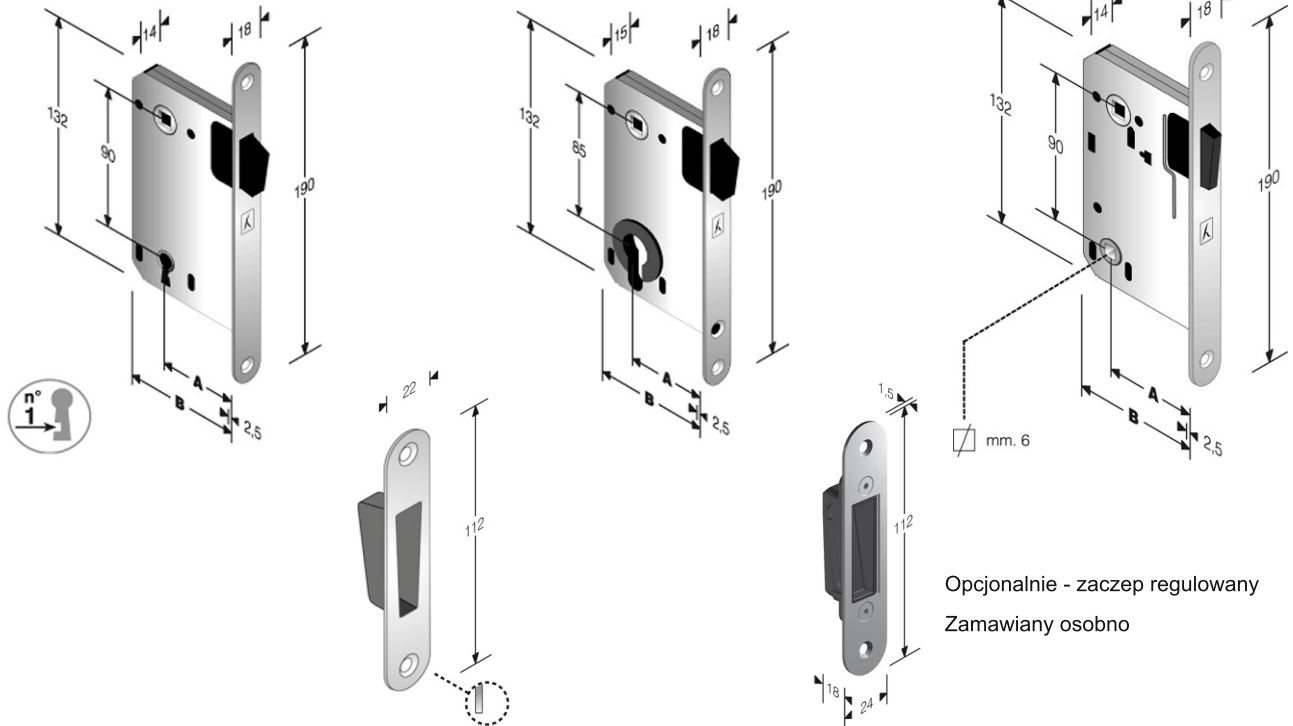

B-FOUR

