



MADE IN ITALY

2014 CATALOGO MANIGLIE CRYSTAL  
CRYSTAL HANDLES CATALOGUE



---

# Catalogo Crystal *Crystal catalogue*

Italia, marzo 2014 - Ed. LC009/01  
*Italy, March 2014 - Ed. LC009/01*

---

L'esperienza suggerisce che è praticamente impossibile pubblicare un catalogo privo di errori; saremo quindi grati ai lettori che vorranno segnalarceli scrivendo al seguente indirizzo di posta elettronica: [info@lineacali.it](mailto:info@lineacali.it).

*Experience has taught us that it is practically impossible to print a catalogue with no errors, we would therefore be grateful to any readers that wish to point any out to us at the following address: [info@lineacali.it](mailto:info@lineacali.it).*

Tutti i diritti sono riservati. È vietata la riproduzione integrale o parziale e la diffusione dei contenuti di questo catalogo (siano essi testi, immagini o disegni) senza la preventiva autorizzazione scritta, da richiedere al seguente indirizzo di posta elettronica: [info@lineacali.it](mailto:info@lineacali.it).

*All rights reserved. It is forbidden to reproduce, in part or in whole, and to circulate the contents of this catalogue (text, images and drawings) without prior written authorization, to be requested at the following email address: [info@lineacali.it](mailto:info@lineacali.it).*

Le caratteristiche tecniche sono passibili di modifiche.

*The technical characteristics are subject to modification.*

Il formato elettronico (PDF) di questo catalogo è disponibile all'interno del sito [www.lineacali.it](http://www.lineacali.it).

*The electronic format (PDF) of this catalogue is available on the web site [www.lineacali.it](http://www.lineacali.it)*

#### CREDITI

Studio creativo Fantàsia  
"Dove le idee sputano come funghi."  
[www.studiofantasia.it](http://www.studiofantasia.it)

#### CREDITS

*Fantàsia creative studio  
"Where ideas sprout like mushrooms."  
[www.studiofantasia.it](http://www.studiofantasia.it)*

Direzione artistica: Zack!  
Testi: Alberto Bondoni  
Traduzioni: Aideen Connolly  
Informazioni tecniche: Vanessa Martinelli  
Stampa: Intese Grafiche

*Art direction: Zack!  
Text: Alberto Bondoni  
Translations: Aideen Connolly  
Technical information: Vanessa Martinelli  
Print: Intese Grafiche*

# indice / *index*

---

INDICE COLLEZIONI <i>INDEX BY COLLECTION</i>	4
AZIENDA <i>FACTORY</i>	5
LEGENDA <i>LEGEND</i>	12
FINITURE <i>FINISHINGS</i>	13
COLLEZIONE CRYSTAL <i>CRYSTAL COLLECTION</i>	14
MANIGLIONI <i>PULL HANDLES</i>	80
ROSETTA RIBASSATA <i>REDUCED ROSE</i>	86
BOCCHETTE <i>ESCUTCHEONS</i>	87
POMOLI PER MOBILI <i>CABINET KNOBS</i>	88
MATERIALE PUBBLICITARIO <i>ADVERTISING MATERIAL</i>	92
ISTRUZIONI DI MONTAGGIO <i>MOUNTING INSTRUCTIONS</i>	96

# collezioni / collections

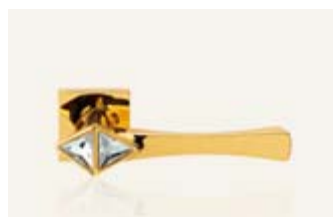

16 Cometa

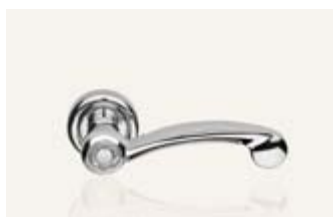

19 Cosmic



22 Crystal



25 Diamante



28 Elika Crystal



31 Elios Crystal



34 Fish Crystal



36 Gemma

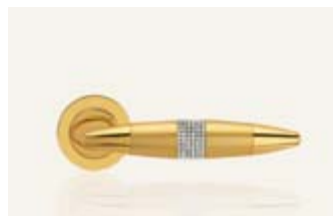

39 Havana Mesh



42 Idea



45 Luce



48 Profilo Mesh



51 Reflex



54 Riflesso Black



56 Riflesso Mesh



59 Riflesso Rocks

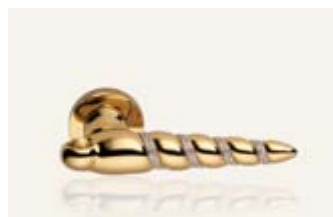

62 Shell Mesh



64 Sintesi Mesh



66 Veronica



69 Viola



71 Zen Mesh

# azienda / *factory*

---

Apriamo le porte con stile  
*We open doors in style*



La differenza tra una maniglia ed un semplice pezzo di ottone nasce nel 1986, quando lanciammo i nostri prodotti seguendo l'idea della funzionalità abbinata al design.

Perché il design senz'anima lo abbiamo provato tutti ed è scomodo, tanto quanto la brutta funzionalità.

Abbiamo quindi scelto di realizzare quelle maniglie che noi stessi metteremmo a casa nostra, maniglie che resistano a tutto: usura, urti, tempo, grazie ad innovative tecniche di fissaggio e di protezione, come la finitura PVD Zirconium Protection.

Al contempo, le abbiamo volute belle, molto belle, come ogni vero accessorio che si rispetti.

E alla fine, visto che volevamo il meglio, ci siamo impegnati a far sì che ogni maniglia venisse concepita e realizzata esclusivamente in Italia, rispettando pienamente i requisiti di legge previsti dalle normative europee.

A questo punto, provate ad immaginare la maniglia perfetta per la vostra abitazione o per il vostro ufficio: probabilmente la troverete qui.

*The difference between a handle and a simple piece of brass arose in 1986, when we launched our products that combined both functionality and design.*

*We've all tried design without a soul and it's awkward, just like brute functionality.*

*We therefore chose to create handles that we ourselves would choose for our own house, handles that resist everything: wear, blows, time, thanks to innovative fixing and protection techniques such as the Zirconium Protection finish - PVD.*

*At the same time, we wanted our handles to be attractive, like all accessories should be.*

*And finally, because we wanted the best, we committed ourselves to ensuring that every handle was designed and created exclusively in Italy, in full compliance with the legislative requirements of European standards.*

*And now, try and image the ideal handle for your house or office: the chances are you'll find it here.*



# azienda / *factory*

Nel futuro probabilmente le porte  
si apriranno con il pensiero...

fino ad allora, però, sogneranno  
sempre una maniglia Linea Calì.







## Produciamo maniglie di alta qualità, e lo facciamo solo in Italia.

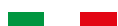

Siamo orgogliosi di garantire ai clienti la produzione italiana di tutti i nostri prodotti nel rispetto delle più recenti normative Europee in tema di qualità delle materie prime utilizzate, caratteristiche tecniche e resistenza dei trattamenti protettivi delle superfici (rif. UNI EN ISO 9227).

A riprova di ciò su ogni articolo che commercializziamo stampiamo un marchio di riconoscimento che ne attesta l'autenticità, garantendo così al cliente l'acquisto di una maniglia di alta qualità interamente prodotta in Italia.

Garantiamo inoltre 10 anni i prodotti con finiture cromo lucido o cromo satinato, e 20 anni se trattati con il trattamento Zirconium Protection (PVD), adatto dove è richiesta una resistenza particolare a causa di difficili situazioni climatiche come salsedine, alta umidità o situazioni di impiego usuranti.

*We are proud that we can guarantee our customers products that are manufactured entirely in Italy, in compliance with the most recent European standards on the quality of the raw materials used, the technical characteristics and the resistance of surface treatments (ref. UNI EN ISO 9227).*

*As evidence thereof, we mark each and every item that we sell, certifying its authenticity, thus guaranteeing the customer a high quality handle produced entirely in Italy.*

*Furthermore, all our products with a polished chrome or satin chrome finish are covered by a 10 year guarantee and by a 20 year guarantee if treated with a physical vapour deposition (PVD) using Zirconium Protection, a coating that is ideal whenever a particularly high resistance is required due to difficult climatic situations such as high salt content or humidity in the air or situations of high wear and tear.*



# azienda / factory

Amiamo il "verde" che ci circonda, e lo rispettiamo in ogni processo produttivo.

Siamo estremamente rispettosi dell'ambiente che circonda la nostra azienda, la nostra vita, perciò adottiamo un comportamento eco-responsabile per ridurre gli sprechi e migliorare la qualità della vita sul posto di lavoro.

*We respect the environment that surrounds our company, our life. We therefore adopt an environmentally responsible behaviour to reduce wastage and improve the quality of life in the workplace.*

Tutti i principali processi produttivi vengono svolti in un'ottica eco-sostenibile, inoltre pretendiamo che i nostri fornitori adottino un Sistema di Gestione Ambientale per prevenire l'inquinamento, purificando le emissioni in atmosfera e depurando le acque reflue.

*All the principle production processes are performed with a view to sustainability and we also require that our suppliers adopt an Environmental Management System to prevent pollution, purifying atmospheric emissions and waste water.*

Un grosso impegno, che ci sentiamo di portare avanti sempre con più convinzione perché ci crediamo fermamente.

*A major commitment but one that we are pleased to pursue with increasing conviction as we so firmly believe in it.*





Grazie alla nostra esperienza pluriennale nel mondo del lusso, abbiamo intuito la necessità da parte dei nostri clienti di possedere collezioni sempre più particolari ed esclusive.

Più di 20 anni fa abbiamo così iniziato a trasformare oggetti di uso comune in gioielli dalle mille sfaccettature impreziosendoli con cristalli SWAROVSKI ELEMENTS originali.

Cometa, Cosmic, Crystal, Diamante, Erika Crystal, Elios Crystal, Fish Crystal, Gemma, Havana Mesh, Idea, Luce, Opera Crystal, Profilo Mesh, Reflex, Riflesso Black, Riflesso Mesh, Riflesso Rocks, Shell Mesh, Sintesi Mesh, Tiffany Mesh, Veronica, Viola e Zen Mesh sono i nomi di tutte le collezioni di pregio dagli infiniti riflessi di luce MADE WITH SWAROVSKI ELEMENTS.

*Thanks to our years of experience in the world of luxury, we understand our customers' need to possess collections that are more and more special and exclusive.*

*So over 20 years ago we started transforming everyday objects into multi faceted jewels with original SWAROVSKI ELEMENTS.*

*Cometa, Cosmic, Crystal, Diamante, Erika Crystal, Elios Crystal, Fish Crystal, Gemma, Havana Mesh, Idea, Luce, Opera Crystal, Profilo Mesh, Reflex, Riflesso Black, Riflesso Mesh, Riflesso Rocks, Shell Mesh, Sintesi Mesh, Tiffany Mesh, Veronica, Viola and Zen Mesh are the collections with a infinite reflections of light MADE WITH SWAROVSKI ELEMENTS crystals.*



# azienda / *factory*

Produciamo maniglie di lusso  
impreziosite dagli inimitabili cristalli  
SWAROVSKI ELEMENTS.



# legenda / legend



Novità  
*New*



Design brevettato - diritto di esclusiva sulla produzione e commercializzazione  
*Patented design - exclusive right on manufacturing and marketing*



Slim - rosetta bassa h. 6 mm  
*Slim - reduced rose h. 6 mm*

# finiture / *finishings*

---

BA	bianco opaco <i>matt white</i>
CR	cromo lucido <i>polished chrome</i>
CS	cromo satinato <i>satin chrome</i>
OZ	oro zecchino <i>gold plated</i>
PV	titanio <i>titanium</i>
VE	nero opaco <i>matt black</i>

Collezioni impreziosite da  
SWAROVSKI ELEMENTS.

*Collection embellished with  
SWAROVSKI ELEMENTS.*



# Crystal





# Cometa

COLLEZIONE 2010  
2010 COLLECTION



Come una stella cadente segna il cielo con la sua luce, Cometa accende ogni ambiente grazie al cristallo SWAROVSKI ELEMENTS incastonato nell'impugnatura come un diadema.

Just as a shooting star brightens the sky with its light, Cometa lights up all rooms thanks to the SWAROVSKI ELEMENTS crystal set in the hand grip like a crown.

ONLY MADE IN ITALY





---

COMETA | FINITURE / FINISHINGS



CR cromo lucido  
*polished chrome*



CS cromo satinato  
*satin chrome*



OZ oro zecchino  
*gold plated*



PV titanio  
*titanium*



COMETA | MODELLI / MODELS



COD. 1290 RB 019

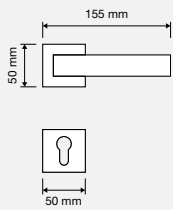

COD. 1290 PL

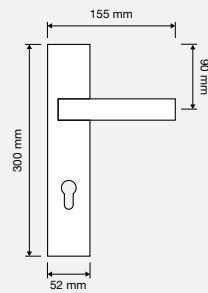

COD. 1290 DK

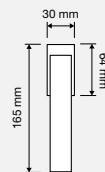

COLLEZIONE 2011  
2011 COLLECTION

# Cosmic



Il concetto di maniglia classica viene riletto in chiave moderna e arricchito da dettagli contemporanei come il ricciolo dell'impugnatura e il cristallo SWAROVSKI ELEMENTS di forma squisitamente circolare.

The conventional handle is given a modern twist and enhanced with contemporary details such as the curl of the hand grip and the SWAROVSKI ELEMENTS crystal with the delightfully rounded shape.

ONLY MADE IN ITALY

PATENTED  
DESIGN





CR cromo lucido  
*polished chrome*



CS cromo satinato  
*satin chrome*



OZ oro zecchino  
*gold plated*



1335 swarovski cristallo  
*crystal swarovski*



1336 swarovski jet nero  
*black jet swarovski*



COD. 1335 RB 103

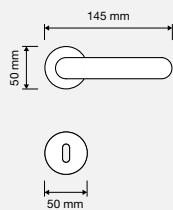

COD. 1335 PL

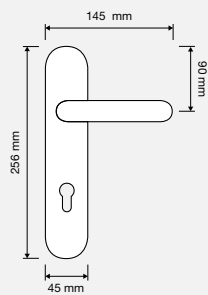

COD. 1335 DK

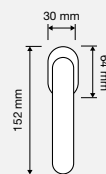

COD. 209 PB MM.22



COD. 209 PB MM.30



# Crystal

COLLEZIONE 1992  
1992 COLLECTION



La bellezza dei cristalli SWAROVSKI ELEMENTS è oggetto di culto in questa collezione dalle linee importanti ma allo stesso tempo eleganti.

The beauty of SWAROVSKI ELEMENTS crystals is an object of worship in this collection that is made up of formal but at the same time elegant lines.

ONLY MADE IN ITALY

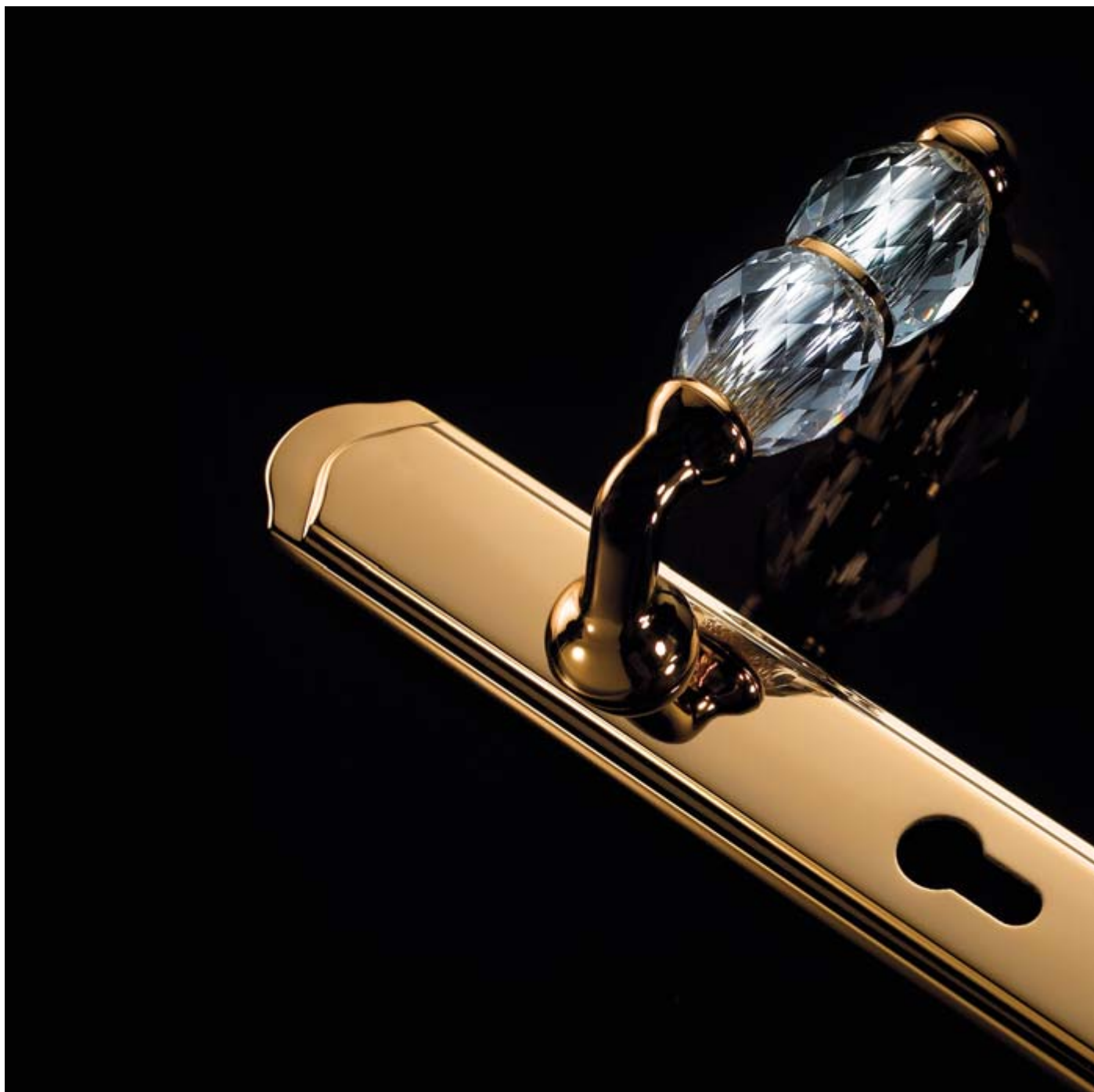



CR cromo lucido  
polished chrome



OZ oro zecchino  
gold plated



COD. 830 RB 103

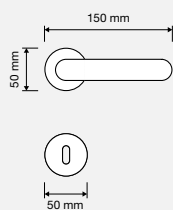

COD. 830 CR



COD. 830 MN 236  
Interassi disponibili / available distances  
236 - 310 - 420 - 500

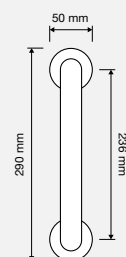





CRYSTAL | MODELLI / MODELS



COD. 830 PT

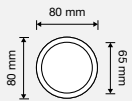

COD. 200 PB 0020 - PB 0030 - PB 0040

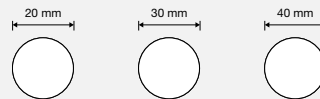

COLLEZIONE 2004  
2004 COLLECTION

# Diamante



Un grande classico del Made in Italy dall'eleganza discreta acquisisce una seconda giovinezza grazie alla preziosa impugnatura realizzata interamente in cristallo SWAROVSKI ELEMENTS.

A great classic, clearly Made in Italy, with a discreet elegance, acquires a second youth thanks to the precious hand grip made entirely of SWAROVSKI ELEMENTS crystal.

ONLY MADE IN ITALY





CR cromo lucido  
polished chrome



OZ oro zecchino  
gold plated



COD. 905 RB 103

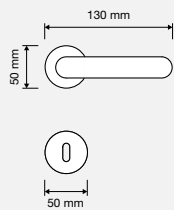

COD. 905 PL

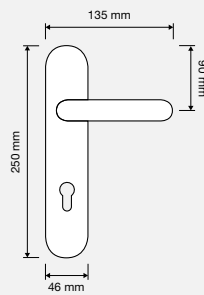

COD. 905 MN 210

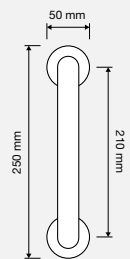



DIAMANTE | MODELLI / MODELS



COD. 905 DK

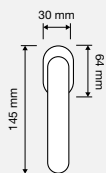

COD. 905 CR



COD. 905 AB

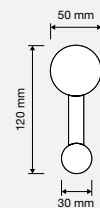

# Elika Crystal

COLLEZIONE 2003  
2003 COLLECTION



Linee sfuggenti donano un'inaspettata dinamicità alle importanti forme, rese ancor più sorprendenti dalla luce emanata da un cristallo SWAROVSKI ELEMENTS.

Elusive lines give an unexpected dynamic to the formal shapes, made even more surprising by the light released by the SWAROVSKI ELEMENTS crystal.

ONLY MADE IN ITALY





OZ oro zecchino  
gold plated



COD. 991 RB 108

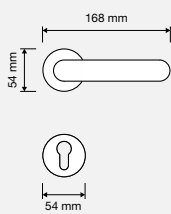

COD. 991 PL

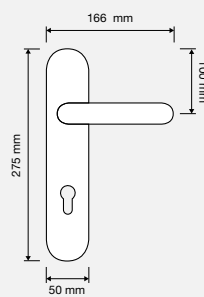

COD. 991 DK

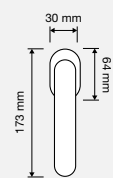



COD. 991 MX

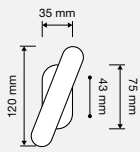

COD. 991 CR



COD. 991 PT

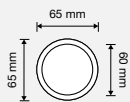

COD. 991 PG 108

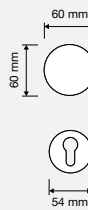

COD. 991 MN 275

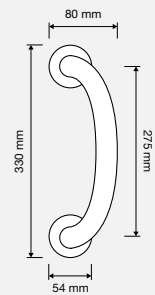

COLLEZIONE 2011  
2011 COLLECTION

# Elios Crystal



Il concetto di modernità è riassunto in questa maniglia dalle forme decise ma aggraziate, impreziosite da un cristallo SWAROVSKI ELEMENTS che sprigiona riflessi dai mille colori.

This handle is the emblem of modern design with decisive yet graceful shapes, embellished with a SWAROVSKI ELEMENTS crystal that emanates multi coloured reflections.

ONLY MADE IN ITALY



PATENTED  
DESIGN





CR cromo lucido  
*polished chrome*



CS cromo satinato  
*satin chrome*



OZ oro zecchino  
*gold plated*



1340 swarovski cristallo  
*crystal swarovski*



1343 swarovski jet nero  
*black jet swarovski*



1344 swarovski mesh cristallo  
*mesh crystal swarovski*



1348 swarovski black cristallo  
*black crystal swarovski*



COD. 1340 RB 019

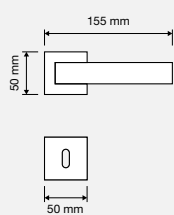

COD. 1340 PL

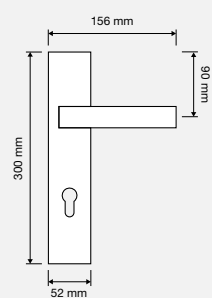

COD. 1340 DK

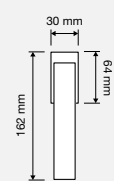

# Fish Crystal



COLLEZIONE 2013  
2013 COLLECTION

Design by  
Dmitry Kozinenko

Una forma semplice ma molto simbolica che evoca la calma, l'armonia e una sorta di mistero, peculiarità dell'ambiente marino.

A simple but very symbolic form that evokes tranquillity, harmony and a sort of mystery, a distinctive feature of marine environments.

ONLY MADE IN ITALY



New!

PATENTED  
DESIGN



CR cromo lucido  
polished chrome



CS cromo satinato  
satin chrome



OZ oro zecchino  
gold plated



COD. 700 RB 023

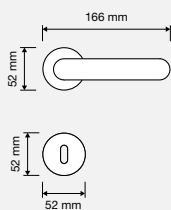

COD. 700 PL

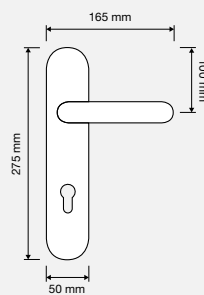

COD. 700 DK

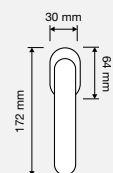

# Gemma

COLLEZIONE 2006  
2006 COLLECTION



Un cristallo SWAROVSKI ELEMENTS definisce la particolare impugnatura di questa collezione dalle reminiscenze classiche, nata per impreziosire gli ambienti più raffinati.

A splendid SWAROVSKI ELEMENTS crystal defines the particular hand grip of this collection that is reminiscent of classical designs, created to embellish the most refined surroundings.

ONLY MADE IN ITALY

PATENTED  
DESIGN





---

GEMMA | FINITURE / FINISHINGS



CR cromo lucido  
*polished chrome*



CS cromo satinato  
*satin chrome*



OZ oro zecchino  
*gold plated*

---

GEMMA | FANTASIE / FANTASY



1120 swarovski cristallo  
*crystal swarovski*



1121 swarovski viola  
*violet swarovski*



GEMMA | MODELLI / MODELS



COD. 1120 RB 103

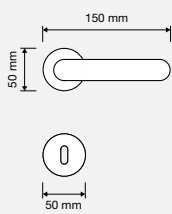

COD. 1120 PL

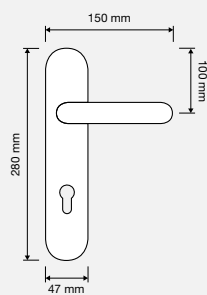

COLLEZIONE 2006  
2006 COLLECTION

# Havana Mesh



Come un gioiello esalta la bellezza di una donna, un anello tempestato di cristalli SWAROVSKI ELEMENTS illumina questa collezione sprigionando infiniti riflessi dai mille colori.

Just as a jewel brings out the beauty in a woman, a ring studded with SWAROVSKI ELEMENTS crystals illuminates this collection bursting with infinite multi colour reflections.

ONLY MADE IN ITALY







CR cromo lucido  
polished chrome



OZ oro zecchino  
gold plated

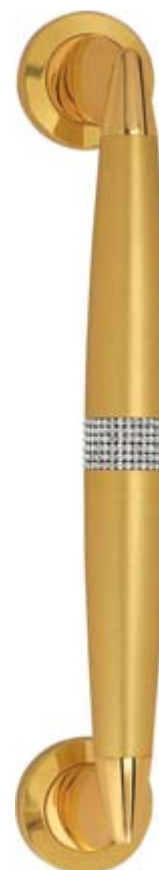

COD. 1090 RB 102

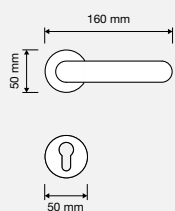

COD. 1090 PL

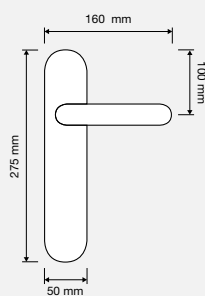

COD. 1090 MN 267

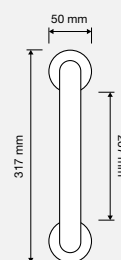



COD. 1090 DK

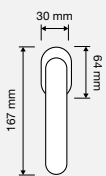



Il cristallo SWAROVSKI ELEMENTS incastonato nell'impugnatura pone l'accento sulle linee aggraziate e sinuose che rendono questa collezione "leggera" ma preziosa.

The SWAROVSKI ELEMENTS crystal set in the hand grip highlights the graceful and sinuous lines that make this collection "light" but precious.

ONLY MADE IN ITALY

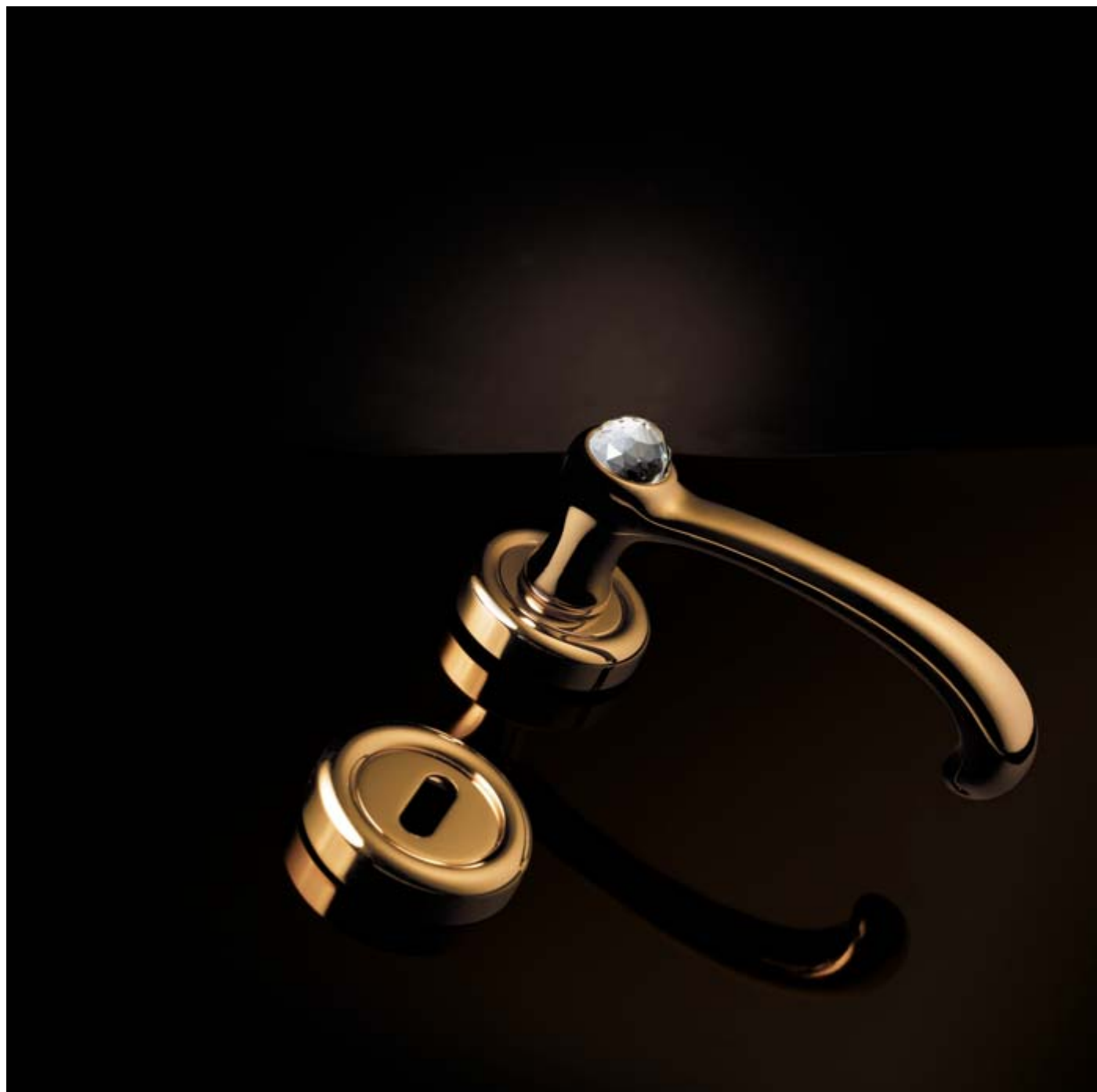



OZ oro zecchino  
gold plated



COD. 871 RB 103

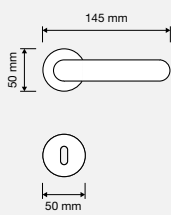

COD. 871 PL

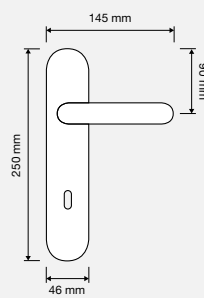

COD. 871 DK

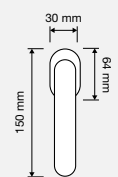



IDEA | MODELLI / MODELS



COD. 871 MX

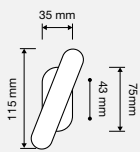

COD. 871 CR

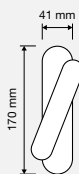

COLLEZIONE 2014  
2014 COLLECTION

# Luce



Le atmosfere del Teatro La Fenice di Venezia e la voce di Maria Callas riaffiorano in questa raffinata collezione, contraddistinta dall'impugnatura in cristallo SWAROVSKI ELEMENTS.

The atmosphere of Teatro La Fenice, the Phoenix Opera House in Venice, and the voice of Maria Callas re-emerges in this refined collection, characterised by the hand grip in SWAROVSKI ELEMENTS crystal.

ONLY MADE IN ITALY





CR cromo lucido  
*polished chrome*



CS cromo satinato  
*satin chrome*



OZ oro zecchino  
*gold plated*

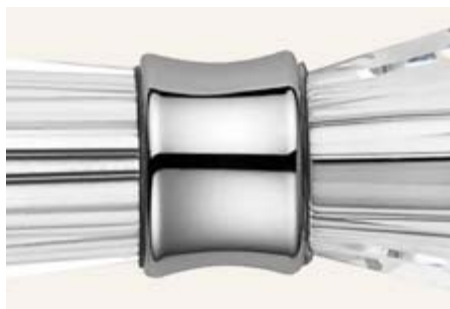

1445 swarovski cristallo  
*crystal swarovski*



1446 swarovski mesh cristallo  
*mesh crystal swarovski*



COD. 1445 RB 023

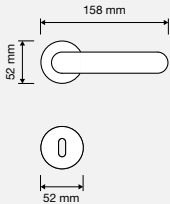

COD. 1445 PL

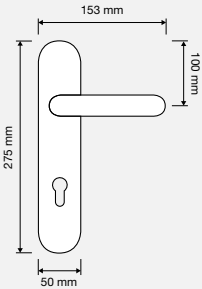

COD. 1445 DK

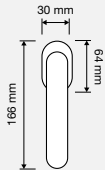



# Profilo Mesh

COLLEZIONE 2005  
2005 COLLECTION



La mano coglie la luce sfiorando un pavé di cristalli SWAROVSKI ELEMENTS che rimanda all'arte orafa più preziosa.

The hand that lightly touches the SWAROVSKI ELEMENTS pavé crystals captures the light and reminds us of the intricate work of the goldsmith.

ONLY MADE IN ITALY



PATENTED  
DESIGN



CR cromo lucido  
*polished chrome*



CS cromo satinato  
*satin chrome*



OZ oro zecchino  
*gold plated*

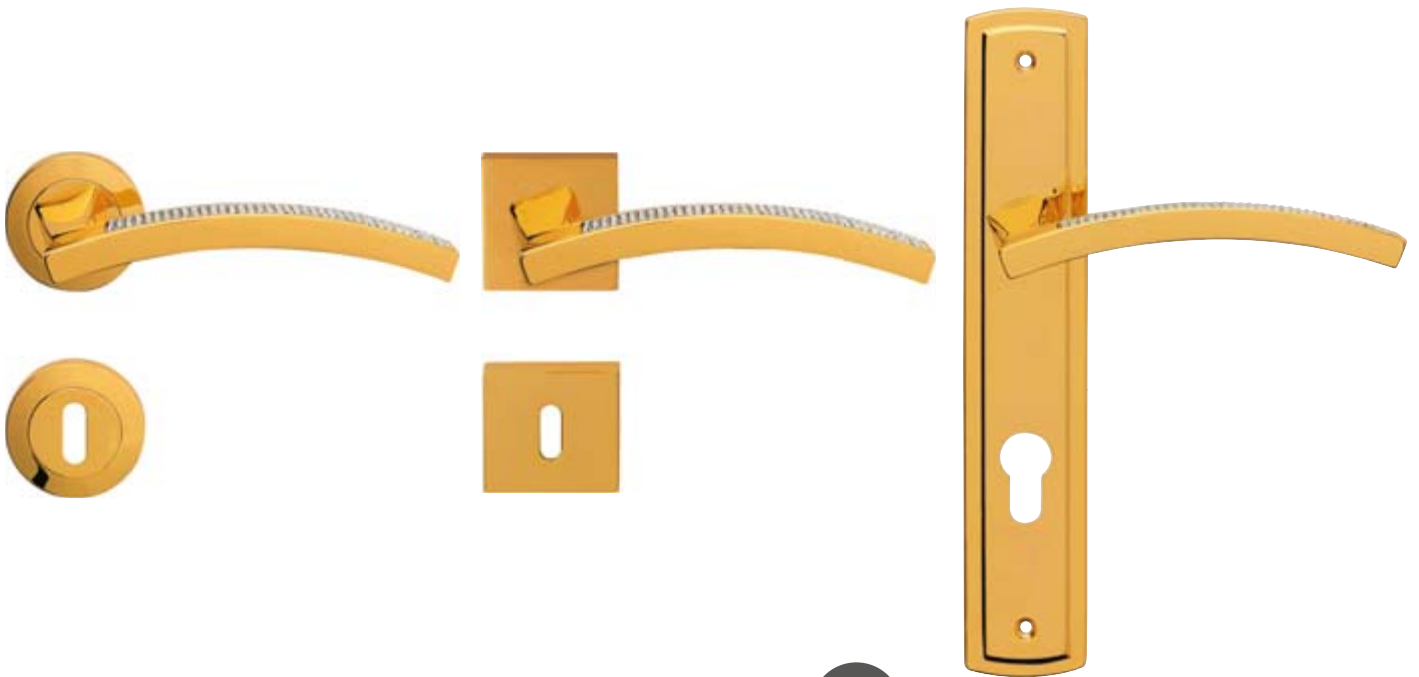

COD. 1041 RB 102

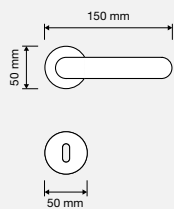

COD. 1041 RB 019

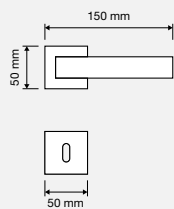

COD. 1041 PL

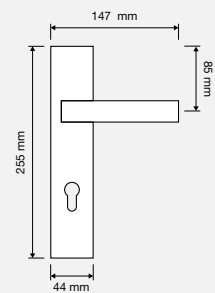



COD. 1041 DK

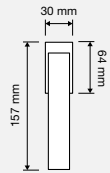

COD. 1041 CR

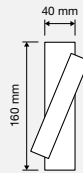

COD. 1041 MN 240

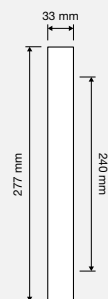

COD. 1041 PI

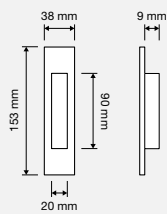

COLLEZIONE 2009  
2009 COLLECTION

# Reflex



Il particolare taglio dei cristalli SWAROVSKI ELEMENTS, studiato per esaltarne i riflessi, rende questa collezione una delle più copiate al mondo.

The particular cut of the SWAROVSKI ELEMENTS crystals, designed to enhance the reflections, make this collection one of the most copied in the world.

ONLY MADE IN ITALY



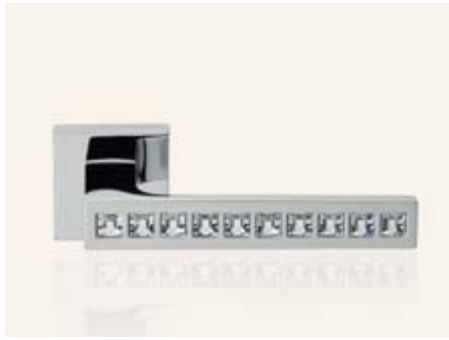

CR cromo lucido  
polished chrome



CS cromo satinato  
satin chrome



OZ oro zecchino  
gold plated



COD. 1215 MN 180

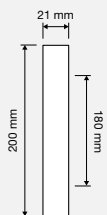

COD. 1215 MN 282



COD. 1215 AB

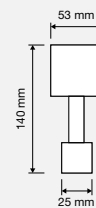



COD. 1215 RB 019

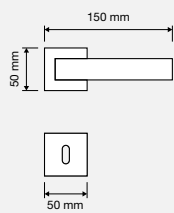

COD. 1216 PL

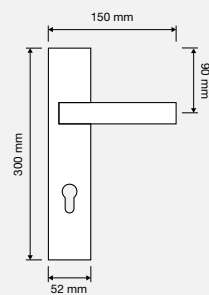

COD. 1215 DK

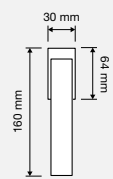

COD. 1215 PT

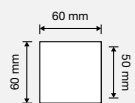

COD. 1215 PG 019

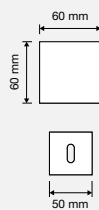

# Riflesso black

COLLEZIONE 2012  
2012 COLLECTION



Un alternarsi di cristalli SWAROVSKI ELEMENTS bianchi e neri, disposti meticolosamente per reinterpretare la luce, cattura lo sguardo con particolarissimi riflessi di luce.

An alternation of black and white SWAROVSKI ELEMENTS crystals, meticulously arranged to reinterpret the light, captures the attention with the most unusual reflections of light.

ONLY MADE IN ITALY

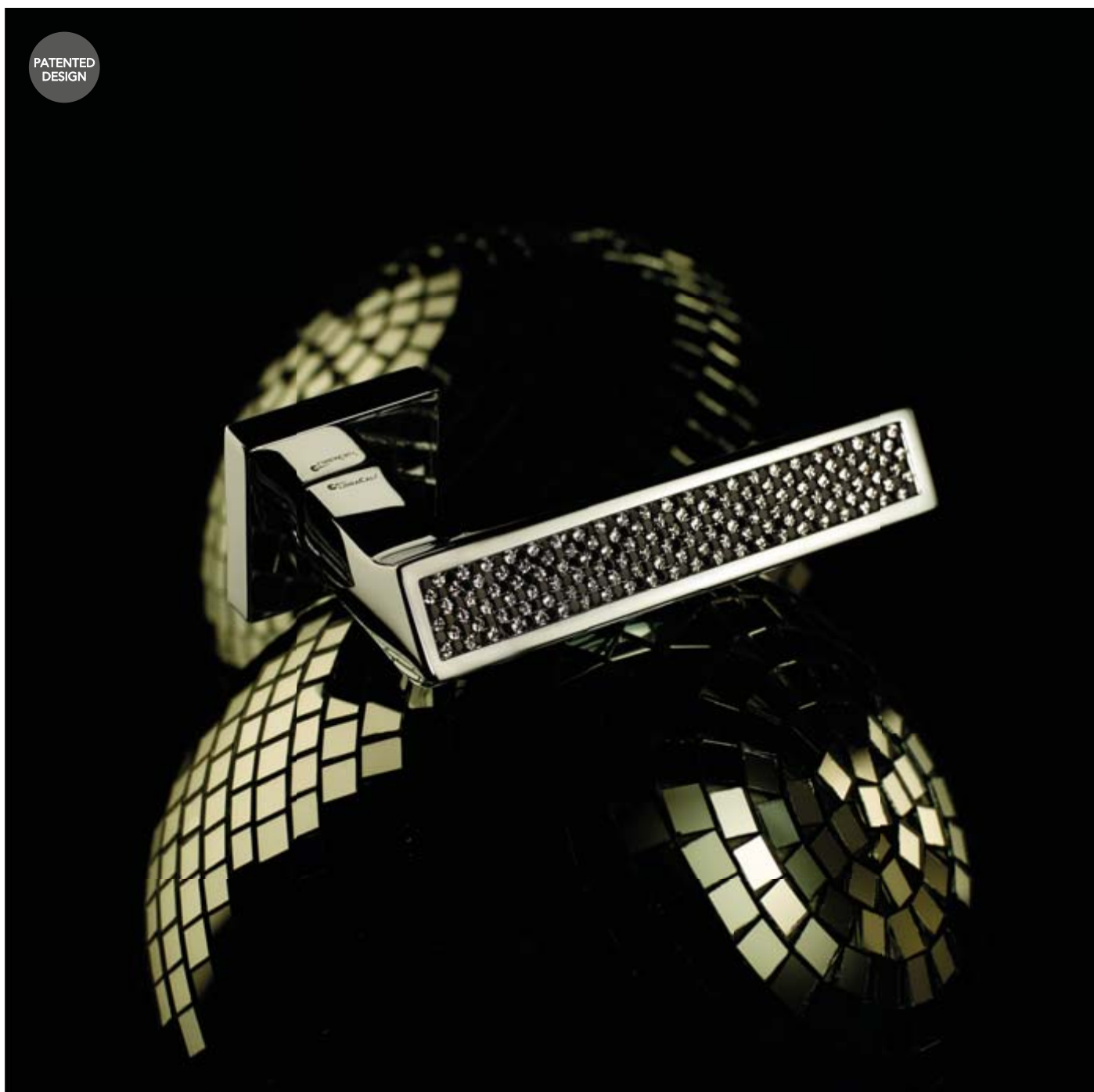



CR cromo lucido  
*polished chrome*



CS cromo satinato  
*satin chrome*



OZ oro zecchino  
*gold plated*



COD. 1352 RB 019

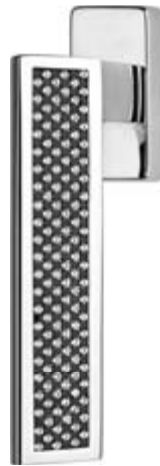
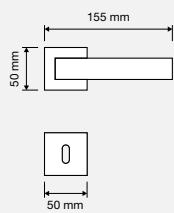

COD. 1352 DK

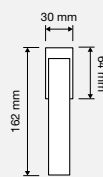



# Riflesso Mesh

COLLEZIONE 2012  
2012 COLLECTION



Il colore profondo e intenso del mare riaffiora alla mente grazie a un particolarissimo pavé di cristalli SWAROVSKI ELEMENTS.

The deep and intense colour of the sea comes to mind thanks to the most particular SWAROVSKI ELEMENTS pavé crystals.

ONLY MADE IN ITALY





---

RIFLESSO MESH | FINITURE / FINISHINGS



CR cromo lucido  
*polished chrome*

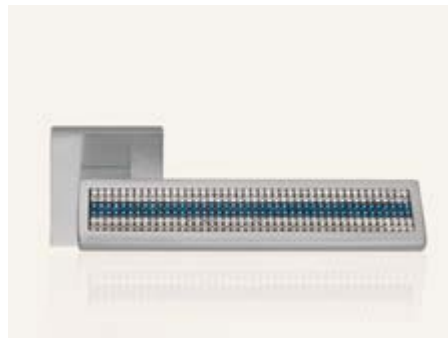

CS cromo satinato  
*satin chrome*

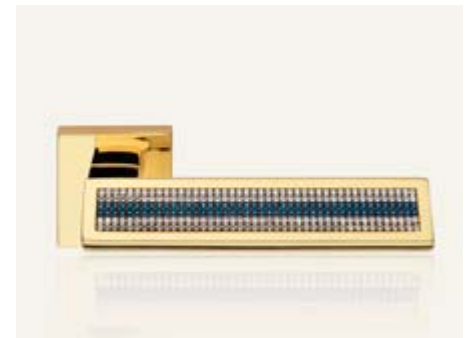

OZ oro zecchino  
*gold plated*

---

RIFLESSO MESH | FANTASIE / FANTASY

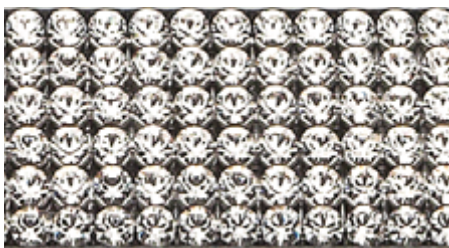

1354 swarovski mesh cristallo  
*mesh crystal swarovski*

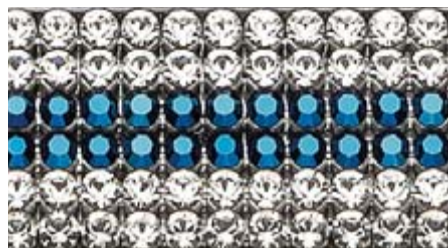

1350 swarovski mesh cristallo/blu  
*mesh crystal/blue swarovski*



RIFLESSO MESH | MODELLI / MODELS



COD. 1350 RB 019

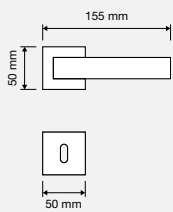

COD. 1350 PL

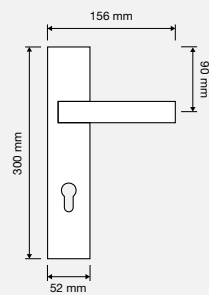

COD. 1350 DK

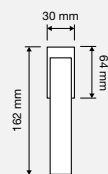

COLLEZIONE 2012  
2012 COLLECTION

# Riflesso Rocks



Un oggetto di uso comune si trasforma in gioiello dalle mille sfaccettature e dagli infiniti riflessi di luce grazie a particolarissimi pavé di cristalli SWAROVSKI ELEMENTS.

An everyday object is transformed into a jewel with infinite reflections and refractions thanks to the very particular pavé SWAROVSKI ELEMENTS crystals.

ONLY MADE IN ITALY





BA bianco opaco  
*matt white*



CR cromo lucido  
*polished chrome*

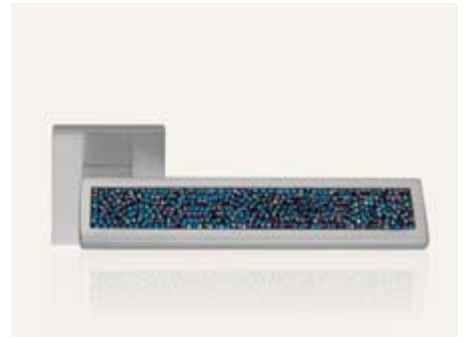

CS cromo satinato  
*satin chrome*



OZ oro zecchino  
*gold plated*



VE nero opaco  
*matt black*

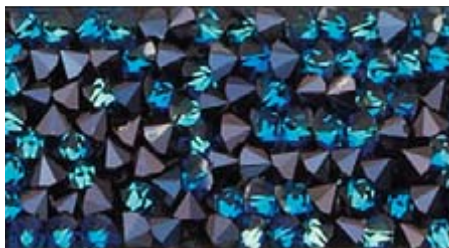

1351 swarovski rocks blue  
*rocks blue swarovski*

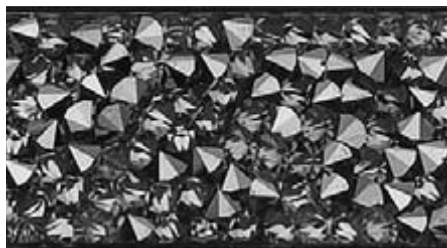

1359 swarovski rocks grey  
*rocks grey swarovski*

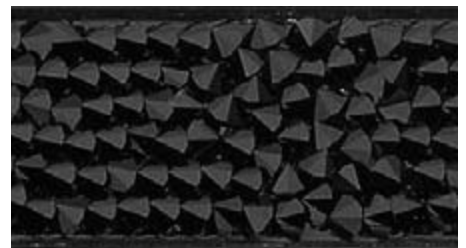

1358 swarovski rocks Jet  
*rocks Jet swarovski*



COD. 1358 RB 019

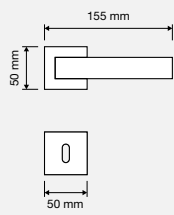

COD. 1358 DK

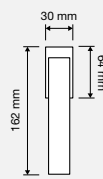

# Shell Mesh

COLLEZIONE 2013  
2013 COLLECTION



Un gioiello proveniente da un vecchio tesoro scoperto su di un'isola deserta, impreziosito da un torchon di cristalli SWAROVSKI ELEMENTS.

A jewel from an old treasure chest discovered on a desert island, embellished with a torchon of SWAROVSKI ELEMENTS crystals.

ONLY MADE IN ITALY





CR cromo lucido  
polished chrome



CS cromo satinato  
satin chrome



OZ oro zecchino  
gold plated



COD. 694 RB 023

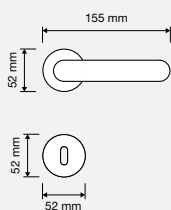

COD. 694 DK

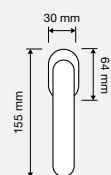

COD. 694 PT

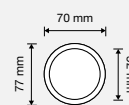

COD. 694 MN 248

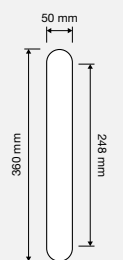



# Sintesi Mesh

COLLEZIONE 2010  
2010 COLLECTION



Un grande pavé di cristalli SWAROVSKI ELEMENTS sottolinea le linee decise e rigorose, nate per distinguersi negli ambienti di design.

The large SWAROVSKI ELEMENTS pavé crystals highlight the decisive and exact lines, created to stand out in designer surroundings.

ONLY MADE IN ITALY





CR cromo lucido  
*polished chrome*



CS cromo satinato  
*satin chrome*

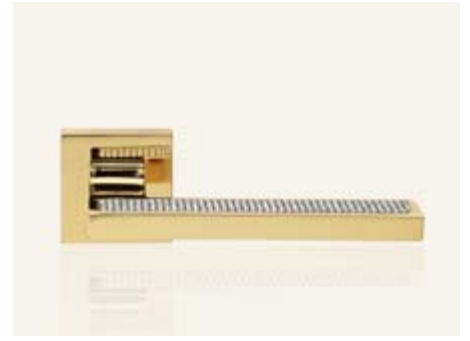

OZ oro zecchino  
*gold plated*

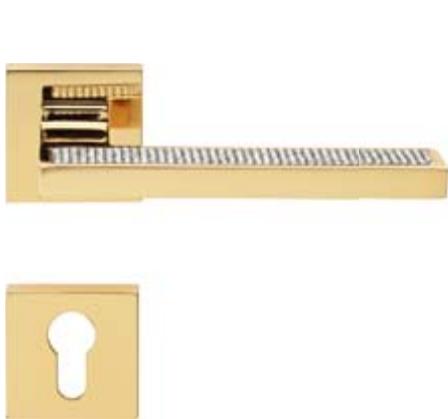

COD. 1301 RB 019

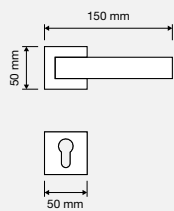

COD. 1301 DK

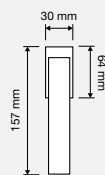

# Veronica

COLLEZIONE 1996  
1996 COLLECTION



Un omaggio alle forme più classiche della maniglieria italiana, rese ancora più eleganti nella loro semplicità grazie all'impugnatura realizzata interamente in cristallo SWAROVSKI ELEMENTS.

A tribute to the most classical shapes of Italian handles, made even more elegant in their simplicity thanks to the hand grip that is made entirely of SWAROVSKI ELEMENTS crystal.

ONLY MADE IN ITALY





CR cromo lucido  
polished chrome



OZ oro zecchino  
gold plated



COD. 900 RB 103

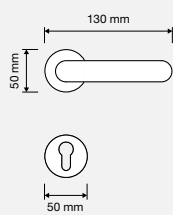

COD. 900 PL

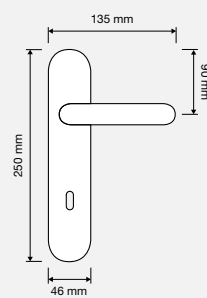

COD. 900 DK

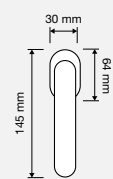



COD. 900 PT 080



COD. 900 PG 103

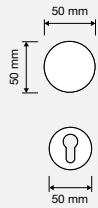

COD. 900 MN 208

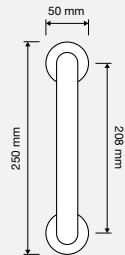

COD. 201 PB MM.24



COD. 201 PB MM.34



COLLEZIONE 2009  
2009 COLLECTION

# Viola



Linee insolite e inaspettate disegnano la silhouette di questa particolarissima collezione, resa ancora più esclusiva da cristalli SWAROVSKI ELEMENTS.

Unusual and unexpected lines form the silhouette of this very remarkable collection that is made even more exclusive by the SWAROVSKI ELEMENTS crystals.

ONLY MADE IN ITALY



PATENTED  
DESIGN



CR cromo lucido  
polished chrome



CS cromo satinato  
satin chrome



OZ oro zecchino  
gold plated



COD. 1220 RB 102

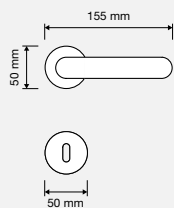

COD. 1221 PL

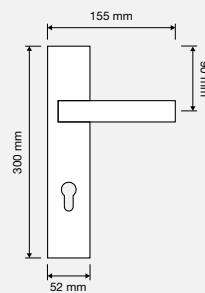

COD. 1220 DK

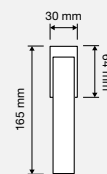

COD. 1220 MN 282

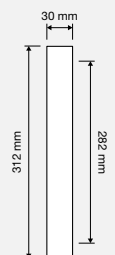

COLLEZIONE 2007  
2007 COLLECTION

# Zen Mesh



Una lunga striscia di piccolissimi cristalli SWAROVSKI ELEMENTS sottolinea il design rigoroso di questa collezione, regalando una luminosità mai vista fino ad ora.

A long band of tiny SWAROVSKI ELEMENTS crystals highlights the meticulous design of this collection, bestowing a radiance unseen until now.

ONLY MADE IN ITALY







CR cromo lucido  
*polished chrome*



CS cromo satinato  
*satin chrome*

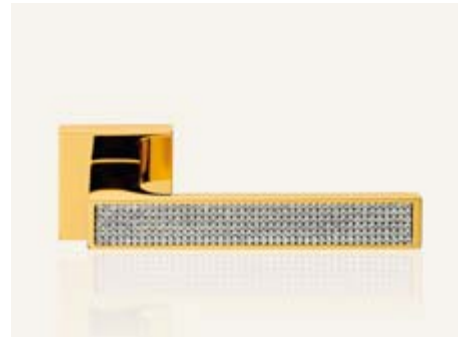

OZ oro zecchino  
*gold plated*

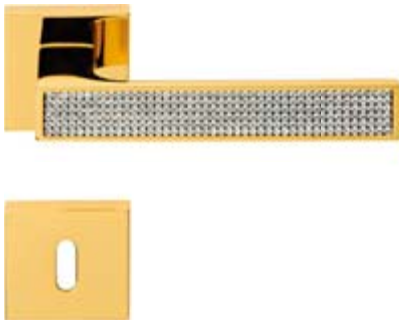

COD. 1157 RB 019

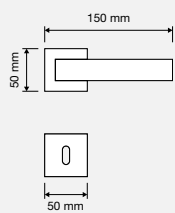

COD. 1151 PL

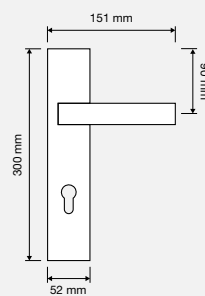

COD. 1157 DK

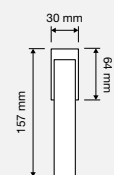



COD. 1151 ED/ES

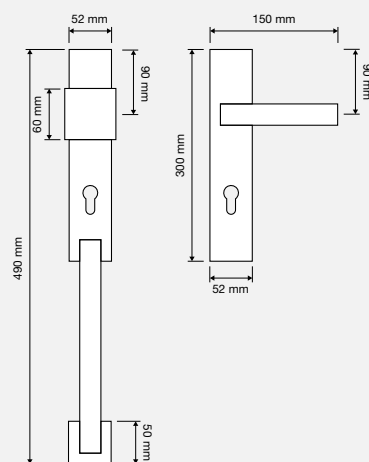

COD. 1157 AB

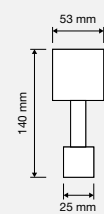



COD. 1157 MN 180

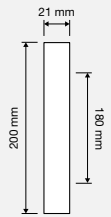

COD. 1157 MN 282

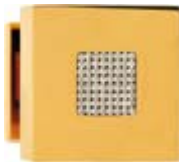
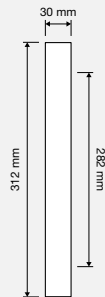

COD. 1157 PT

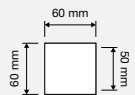

COD. 1157 PG 019

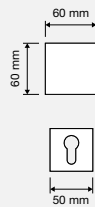







# accessori *accessories*

# POMOLI PER PORTE / DOOR KNOBS



VERONICA | COD. 900 PT 080

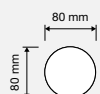

ELIKA CRYSTAL | COD. 991 PT

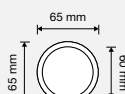

ZEN MESH | COD. 1157 PT

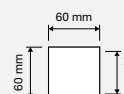

VERONICA | COD. 900 PG 103

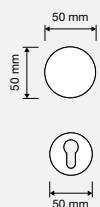
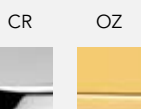

ELIKA CRYSTAL | COD. 991 PG 108

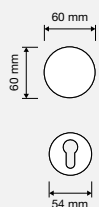

ZEN MESH | COD. 1157 PG 019

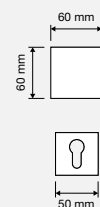
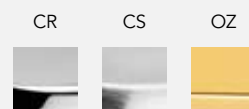



REFLEX | COD. 1215 PT

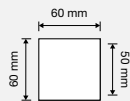

REFLEX | COD. 1215 PG 019

CR CS OZ

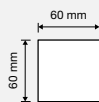

CRYSTAL | COD. 830 PT

CR OZ

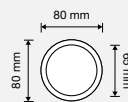

SHELL MESH | COD. 694 PT

CR CS OZ

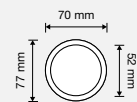



# MANIGLIONI / PULL HANDLES

MODELLI / MODELS



CREATIVE COD. 1147 MN 380

Interassi disponibili / available distances  
380 - 550 - 700

CR OZ

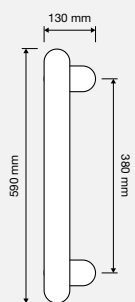

CREATIVE COD. 1145 MN 380

Interassi disponibili / available distances  
380 - 550 - 700

CR OZ

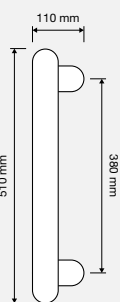

KING COD. 1370 MN 406

Interassi disponibili / available distances  
406 - 580 - 885

CR OZ

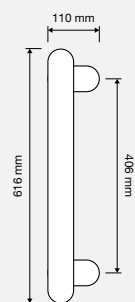



DIAMANTE COD. 905 MN 210

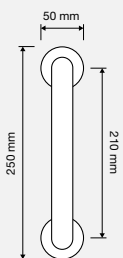
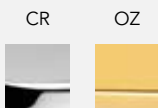

CRYSTAL COD. 830 MN 236  
Interassi disponibili / available distances  
236 - 310 - 420 - 500

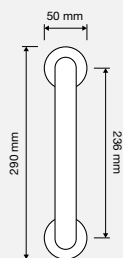
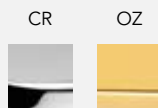

VERONICA COD. 900 MN 208

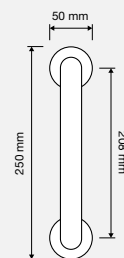
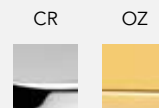

# MANIGLIONI / PULL HANDLES

MODELLI / MODELS



ELIKA CRYSTAL COD. 991 MN 275

OZ

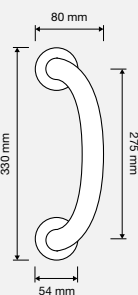

PROFILO MESH COD. 1041 MN 240

CR CS OZ

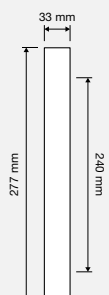
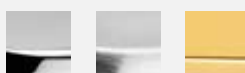

HAVANA MESH COD. 1090 MN 267

CR OZ

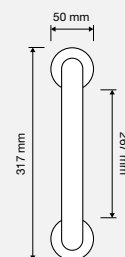



REFLEX COD. 1215 MN 180

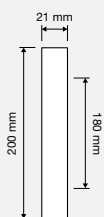
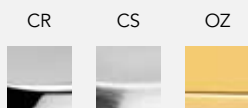

REFLEX COD. 1215 MN 282

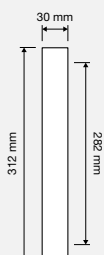
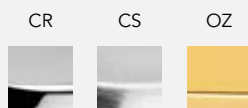

VIOLA COD. 1220 MN 282

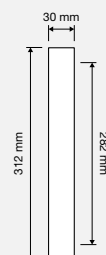
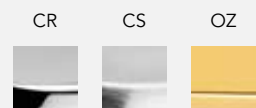

# MANIGLIONI / PULL HANDLES

MODELLI / MODELS

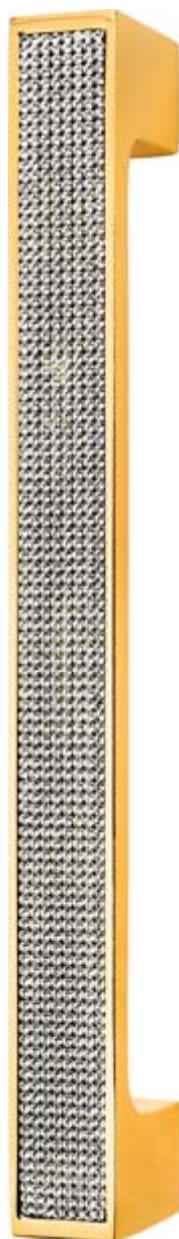

ZEN MESH COD. 1157 MN 180

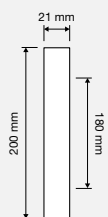
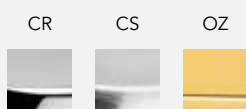

ZEN MESH COD. 1157 MN 282

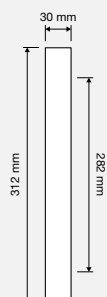
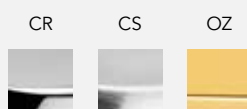

SHELL MESH COD. 694 MN 248

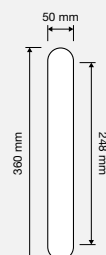

# APPENDIABITI E FERMAPORTE / COAT HOOKS AND DOOR STOPS



ZEN MESH | COD. 1157 AB

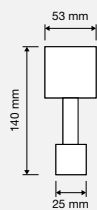

REFLEX | COD. 1215 AB

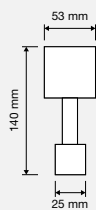

DIAMANTE | COD. 905 AB

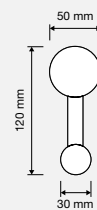

COD. 222 FE CR

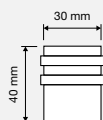

COD. 222 FE OG

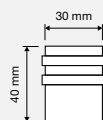

COD. 222 FE OZ

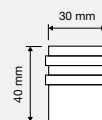

# ROSETTA RIBASSATA / REDUCED ROSE



Per venire incontro alle ultime tendenze stilistiche, Linea Cali ha dato letteralmente un taglio alle rosette e bocchette tradizionali valorizzando così il design di ogni maniglia.

Perfetta negli ambienti più moderni, la nuova linea di rosette e bocchette ribassate è disponibile per tutte le maniglie contraddistinte dal relativo logo.

To meet the latest trends in design, Linea Cali has literally cut the size of traditional roses and escutcheons thus giving more value to the design of every handle.

Perfect in the most modern surroundings, the new line of reduced roses and escutcheons is available for all handles that are identified with the relative logo.



**ROSETTA RIBASSATA  
REDUCED ROSE**



6 mm

**ROSETTA TRADIZIONALE  
STANDARD ROSE**



10 mm



COD. 019 BO 0050



COD. 023 BO 0052



COD. 024 BO 0050



COD. 025 BO 0052



COD. 090 BO 0050



COD. 102 BO 0050



COD. 103 BO 0050



COD. 108 BO 0054





# POMOLI PER MOBILI / CABINET KNOBS



COSMIC CRYSTAL  
COD. 209 PB 0022 0000

COSMIC CRYSTAL  
COD. 209 PB 0022 0000

COSMIC JET NERO / BLACK JET  
COD. 209 PB 0030 0054

COSMIC JET NERO / BLACK JET  
COD. 209 PB 0030 0054

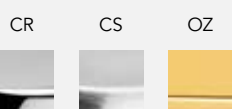

# POMOLI PER MOBILI / CABINET KNOBS



MESH CRYSTAL  
COD. 203 PB 0024 0000

MESH CRYSTAL  
COD. 203 PB 0030 0000

MESH CRYSTAL-BLUE  
COD. 203 PB 0024 0057

MESH CRISTAL-BLUE  
COD. 203 PB 0030 0057

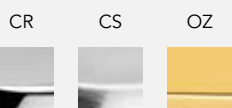

MESH BLACK  
COD. 203 PB 0024 0056

MESH BLACK  
COD. 203 PB 0030 0056

RING CRYSTAL  
COD. 320 PB 0024 0000

RING NERO JET / BLACK JET  
COD. 320 PB 0030 0054

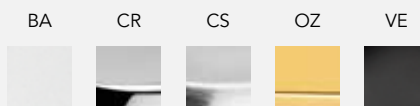
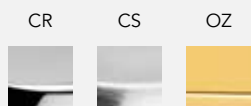

ROCKS JET  
COD. 224 PB 0024 0054

ROCKS JET  
COD. 224 PB 0024 0054

ROCKS GREY  
COD. 224 PB 0030 0055

ROCKS BLUE  
COD. 224 PB 0030 0053

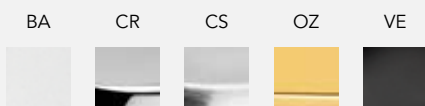

# POMOLI PER MOBILI / CABINET KNOBS



REFLEX NERO JET / BLACK JET  
COD. 321 PB 0024 0054

REFLEX CRYSTAL  
COD. 321 PB 0024 0000

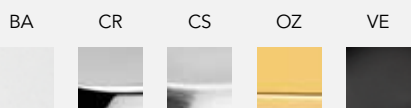

ELIOS CRYSTAL  
COD. 323 PB 0000 0000

ELIOS NERO JET / BLACK JET  
COD. 323 PB 0000 0054

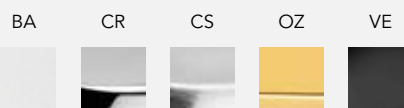
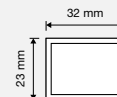

POP-ART BLUE  
COD. 205 PB 0030 0053

POP-ART CRYSTAL  
COD. 205 PB 0030 0000

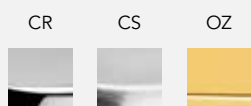

MIRROR BLUE  
COD. 204 PB 0030 0053

MIRROR CRYSTAL  
COD. 204 PB 0030 0000

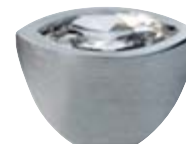
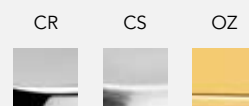

COMETA CRYSTAL  
COD. 324 PB

COMETA CRYSTAL  
COD. 324 PB

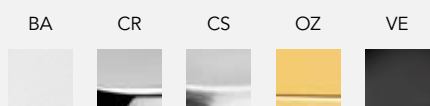

ELIPSE CRYSTAL  
COD. 322 PB

ELIPSE CRYSTAL  
COD. 322 PB

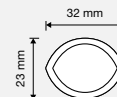

# POMOLI PER MOBILI / CABINET KNOBS



DIAMANTE CRYSTAL  
COD. 206 PB 0024

DIAMANTE CRYSTAL  
COD. 206 PB 0024

VERONICA CRYSTAL  
COD. 201 PB 0024

VERONICA CRYSTAL  
COD. 201 PB 0034

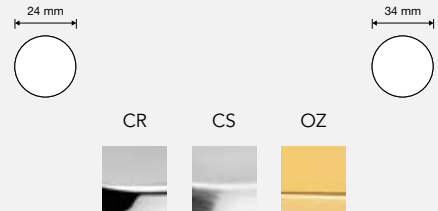
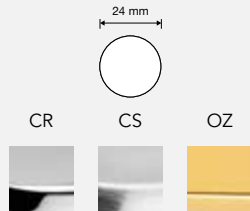

CRYSTAL VIOLA / VIOLET  
COD. 200 PB 0020 0052

CRYSTAL  
COD. 200 PB 0020 0000

CRYSTAL TOPAZIO / TOPAZ  
COD. 200 PB 0020 0050

CRYSTAL VERDE / GREEN  
COD. 200 PB 0020 0051

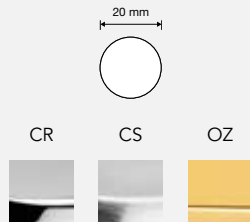

CRYSTAL | COD. 200 PB 0020

CRYSTAL | COD. 200 PB 0030

CRYSTAL | COD. 200 PB 0040

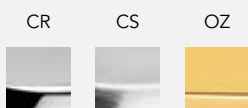



ESPOSITORE DA PAVIMENTO (12 COLLEZIONI)  
FLOOR DISPLAY (12 COLLECTIONS)  
COD. 065 AC

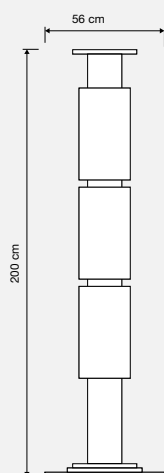

ESPOSITORE DA PARETE (6 COLLEZIONI)  
WALL DISPLAY (6 COLLECTIONS)  
COD. 066 AC

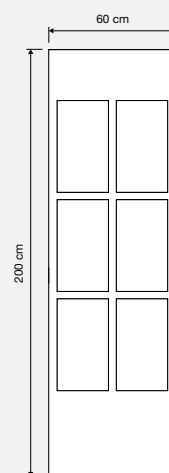



ESPOSITORE DA PAVIMENTO BIFACCIALE  
FLOOR DISPLAY  
COD. 061 AC

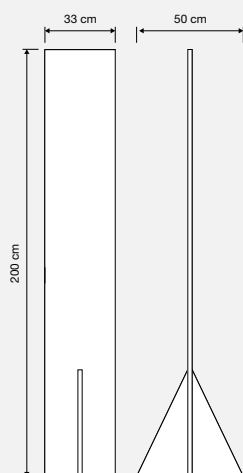

ESPOSITORE DA PARETE  
WALL DISPLAY  
COD. 064 AC

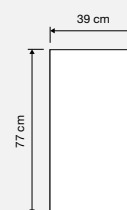



VETROFANIA BIFACCIALE  
WINDOW DECALS  
FISH CRYSTAL | COD. VET 001

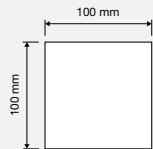

VETROFANIA BIFACCIALE  
WINDOW DECALS  
LIBERTY | COD. VET 002

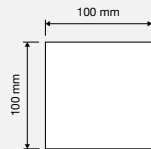

VETROFANIA BIFACCIALE  
WINDOW DECALS  
MARINA | COD. VET 003

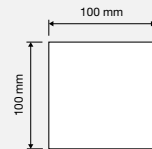

VETROFANIA BIFACCIALE  
WINDOW DECALS  
ROMBO | COD. VET 004

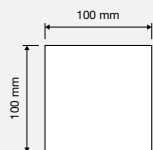

VETROFANIA BIFACCIALE  
WINDOW DECALS  
SHELL MESH | COD. VET 005

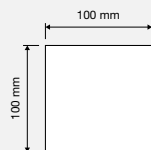

VETROFANIA BIFACCIALE  
WINDOW DECALS  
SISSI | COD. VET 006

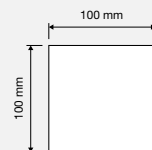



ADESIVO TRASPARENTE / TRANSPARENT STICKER COD. ADR 500

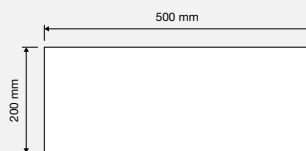

ADESIVO TRASPARENTE / TRANSPARENT STICKER COD. ADR 300

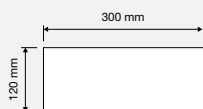

ADESIVO / STICKER COD. ADT 060





# ISTRUZIONI DI MONTAGGIO / MOUNTING INSTRUCTIONS

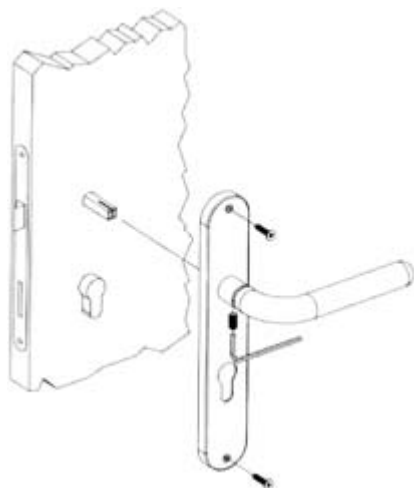

Sistema di montaggio per maniglia con placca.  
*Fixing system for door handle on plate.*

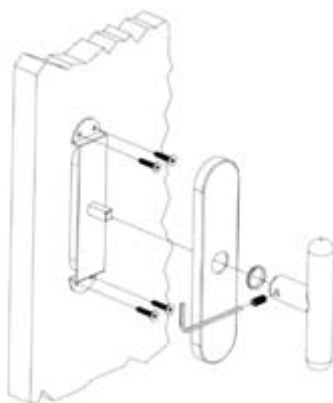

Sistema di montaggio maniglia per finestra.  
*Fixing system for window handle.*

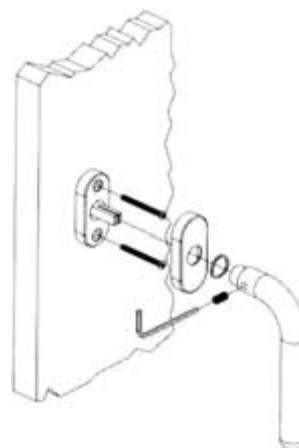

Sistema di montaggio maniglia per finestra con movimento 4 scatti.  
*Fixing system for window pull, 4 clicks positions.*

*Fixing system for window pull, 4 clicks positions.*

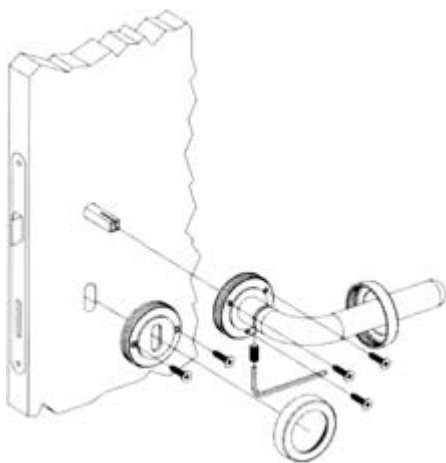

Sistema di montaggio per maniglia con rosetta.  
*Fixing system for door handle on rose.*

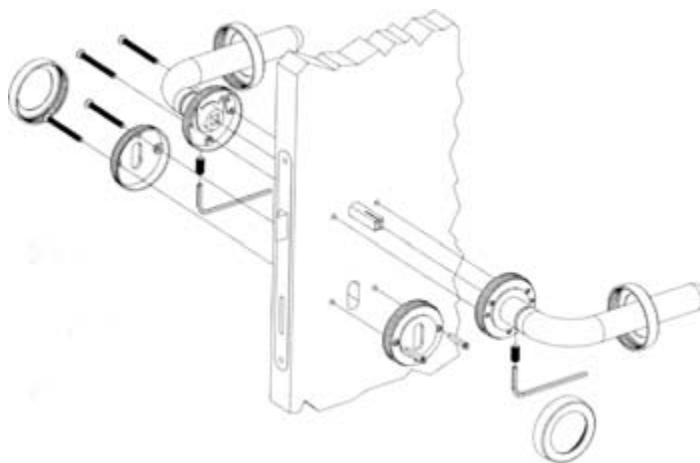

Sistema di montaggio con viti passanti (M3) per maniglia con rosetta.  
*Through assembly (M3 screws) for door handles on rose.*

# ISTRUZIONI DI MONTAGGIO / MOUNTING INSTRUCTIONS

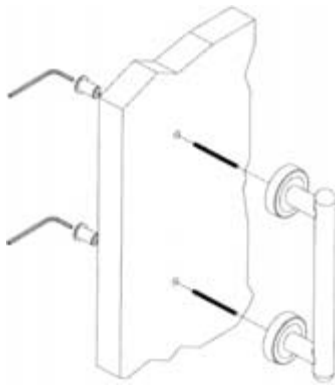

Sistema di fissaggio singolo maniglione su porta in legno (maniglioni con rosette art.102-103-113).

*Fixing system for a single pull handle on a wooden door (pull handles with rose art.102-103-113).*

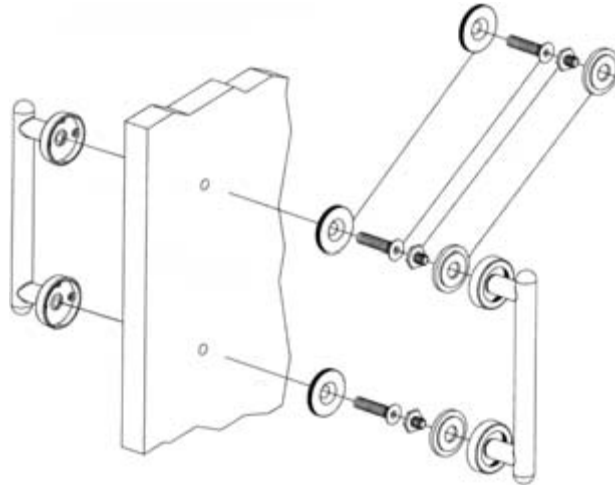

Sistema di fissaggio di una coppia di maniglioni su porta legno (maniglioni con rosette art.102-103). Accessori da ordinare separatamente (rif. listino prezzi art.118MN).

*System for fixing a pair of pull handles on a wooden door (pull handles on rose art.102-103). Fixing accessories to order separately (ref. price list art.118MN).*

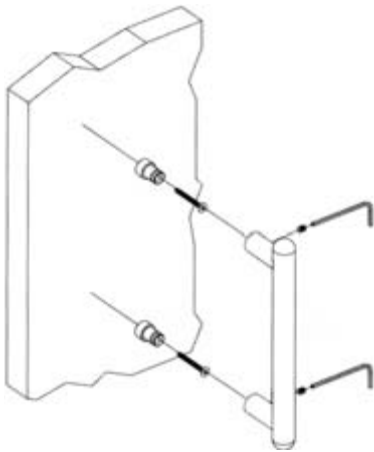

Sistema di fissaggio singolo maniglione su porta in legno.

*Fixing system for a single pull handle on a wooden door.*

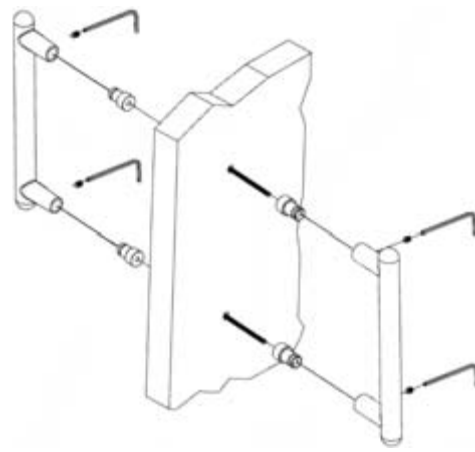

Sistema di fissaggio di una coppia di maniglioni su porta legno.

*System for fixing a pair of pull handles on a wooden door.*

# ISTRUZIONI DI MONTAGGIO / MOUNTING INSTRUCTIONS

Posizionamento e fissaggio con dima per maniglie con rosetta e bocchetta 019.

Fixing system for sets of rose and escutcheon 019 by locating jig.

## CLICK-CLACK! YALE

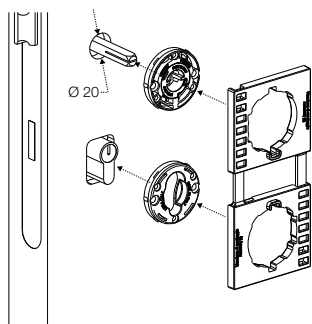

STEP 1/3

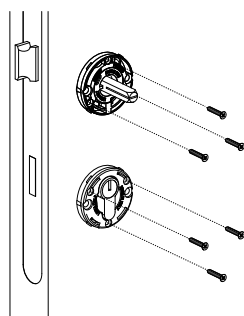

STEP 2/3

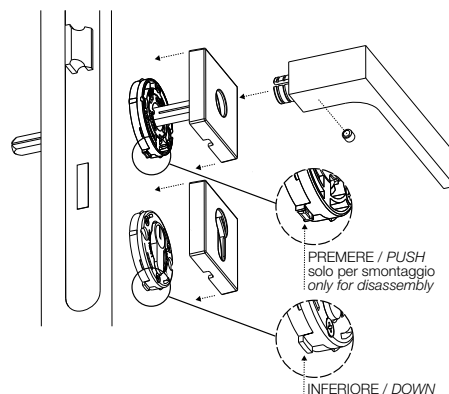

STEP 3/3

## CLICK-CLACK! PATENT KEY

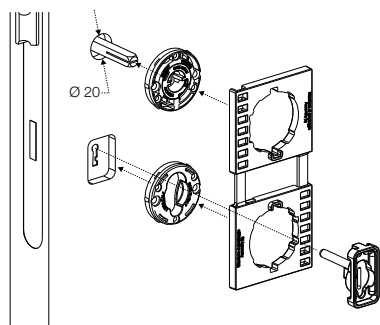

STEP 1/3

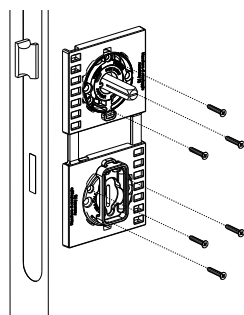

STEP 2/3

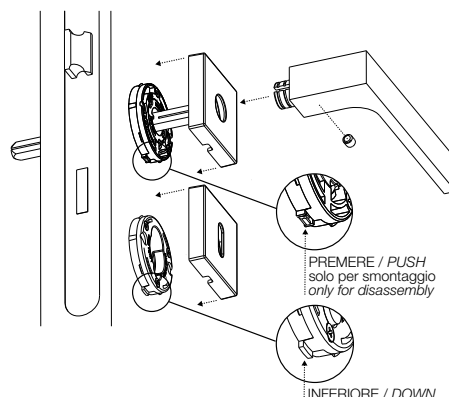

STEP 3/3

## CLICK-CLACK! TOILET

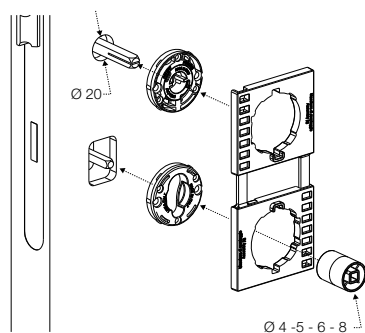

STEP 1/3

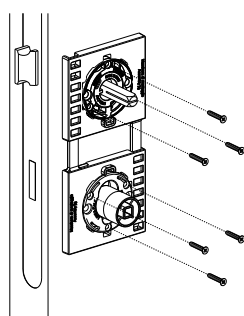

STEP 2/3

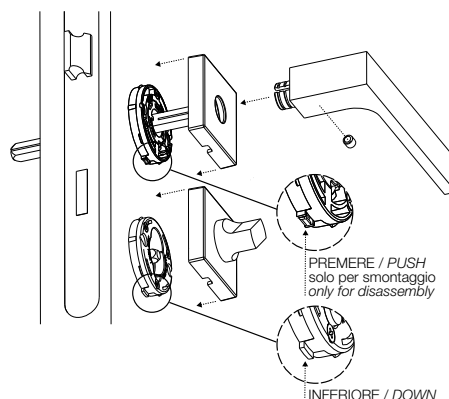

STEP 3/3

# ISTRUZIONI DI MONTAGGIO / MOUNTING INSTRUCTIONS

Dima per esecuzione fori passanti interasse 38mm.  
Drilling jig for bolt through holes 38mm distance.

## CLICK-CLACK! YALE

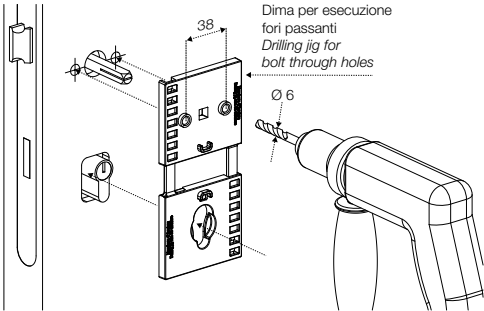

STEP 1/3

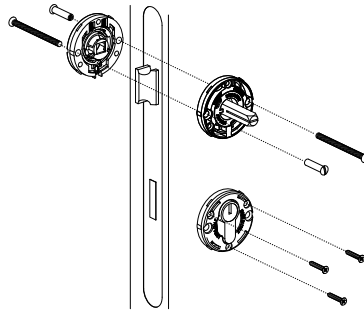

STEP 2/3

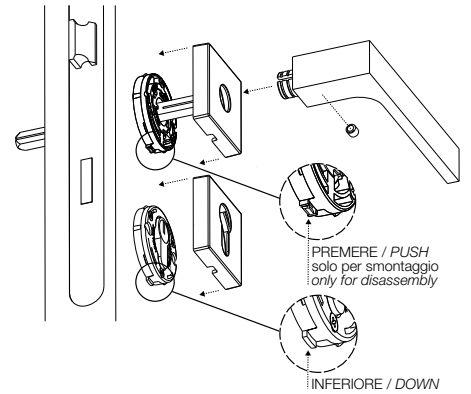

STEP 3/3

## CLICK-CLACK! PATENT KEY

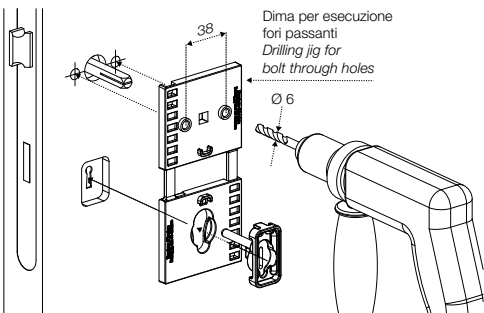

STEP 1/3

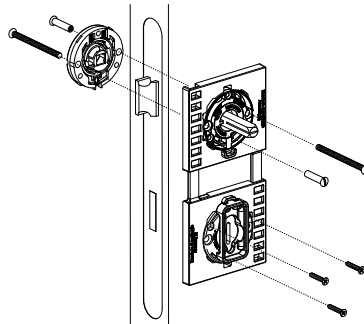

STEP 2/3

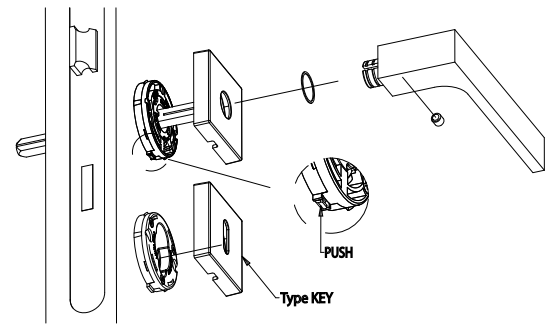

STEP 3/3

## CLICK-CLACK! TOILET

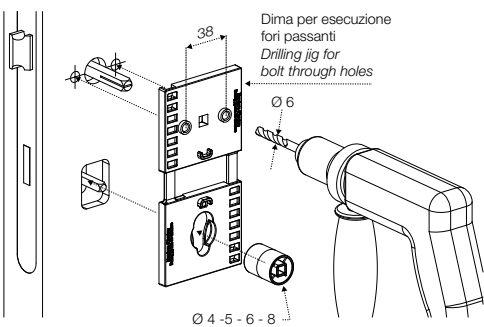

STEP 1/3

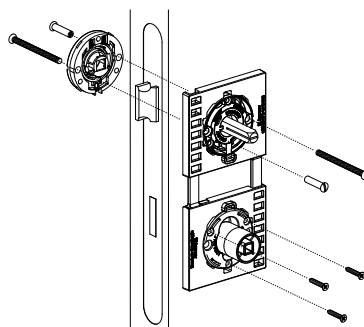

STEP 2/3

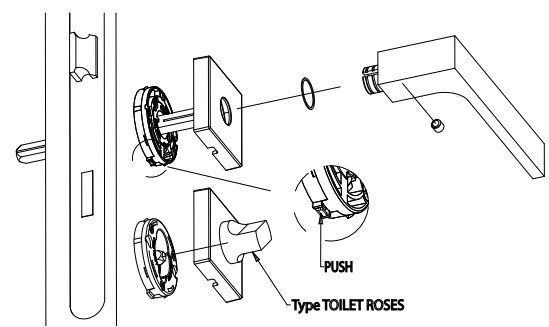

STEP 3/3

---

Linea Cali® è un marchio registrato.

*Linea Cali® is registered trademark.*



**LINEA CALÌ** SRL  
DI CALÌ DANILO, CALÌ PAOLO  
E FACCHETTI MARIO

VIA COMUNALE, 89/91  
25079 VOBARNO (BS) - ITALY

TEL. +390365599198  
FAX +390365599971

EMAIL [INFO@LINEACALI.IT](mailto:INFO@LINEACALI.IT)  
WEB [WWW.LINEACALI.IT](http://WWW.LINEACALI.IT)



CATALOGO MANIGLIE CRYSTAL ED. LC009/01  
CRYSTAL HANDLES CATALOGUE ED. LC009/01